



**ECO** <sup>leaf icon</sup>  
Pair

Single Room  
Energy Recovery Ventilator

## UPGRADED WITH SMART CONTROL

-  New Control Panel
-  Wireless Pairing Operation
-  Multiple Linkage Control
-  WIFI Function





**SAFE**

Auto shutter can prevent the insects entering and the cold air flowing backward when the unit stops. The outer hood can prevent rain draining back and birds nesting.



**MOLD PREVENTION**

The ceramic energy regenerators cover with anti bacteria and anti mildew coating. The efficient ventilation can prevent excessive indoor humidity and mold build-up.



**FLEXIBLE**

Unit can work individually or in pairs.



**EFFICIENT**

High heat recovery efficiency of up to 97% is achieved due to the use of a cellular regenerator.



**EASY INSTALLATION**



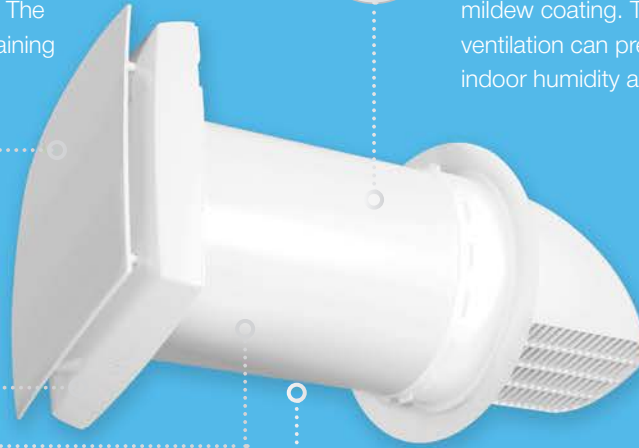

One-stop install through internal wall with a single hole.



# EASY CONTROL

- Using radio signal for communication.
- Longer distances communication up to 15m without barrier.
- Wider control area, multiple devices can be controlled at the same time.
- Accurate control to avoid controlling the wrong device.



						
ON/OFF	Regeneration mode	Supply mode	Exhaust mode	Fan speed increase	Fan speed decrease	LED light switch



# WIFI FUNCTION

*Master the indoor air quality  
anywhere and anytime*

- On/off setting
- Fan speed control
- Working mode selection
- LED lights on/off
- 7\*24 hours timer setting
- Error display
- Online/offline display
- Linkage status display
- Smart control according to local weather
- Linkage control with other appliances with Tuya IoT

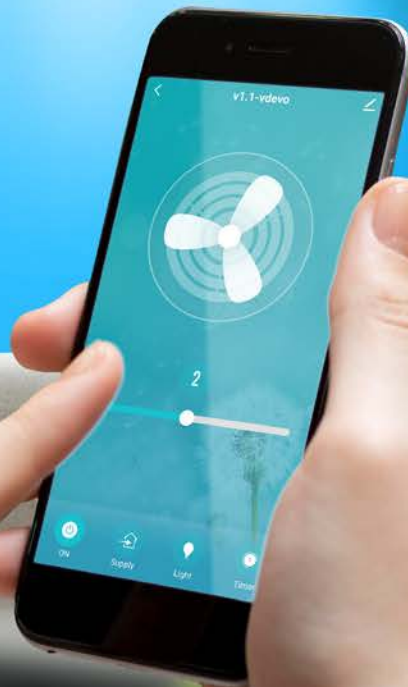

# WIRELESS OPERATION IN PAIR TO ENSURE BALANCED VENTILATION

Wireless connection of master and slave unit, no wiring or dialing needed, 30 meters ultra long distance transmission.

\* 30 meters was tested without barrier and interference. In practical application, it is recommended to install within 8-15 meters. Please avoid the strong interference sources and shielding objects (e.g. iron frames, aluminum ceiling).

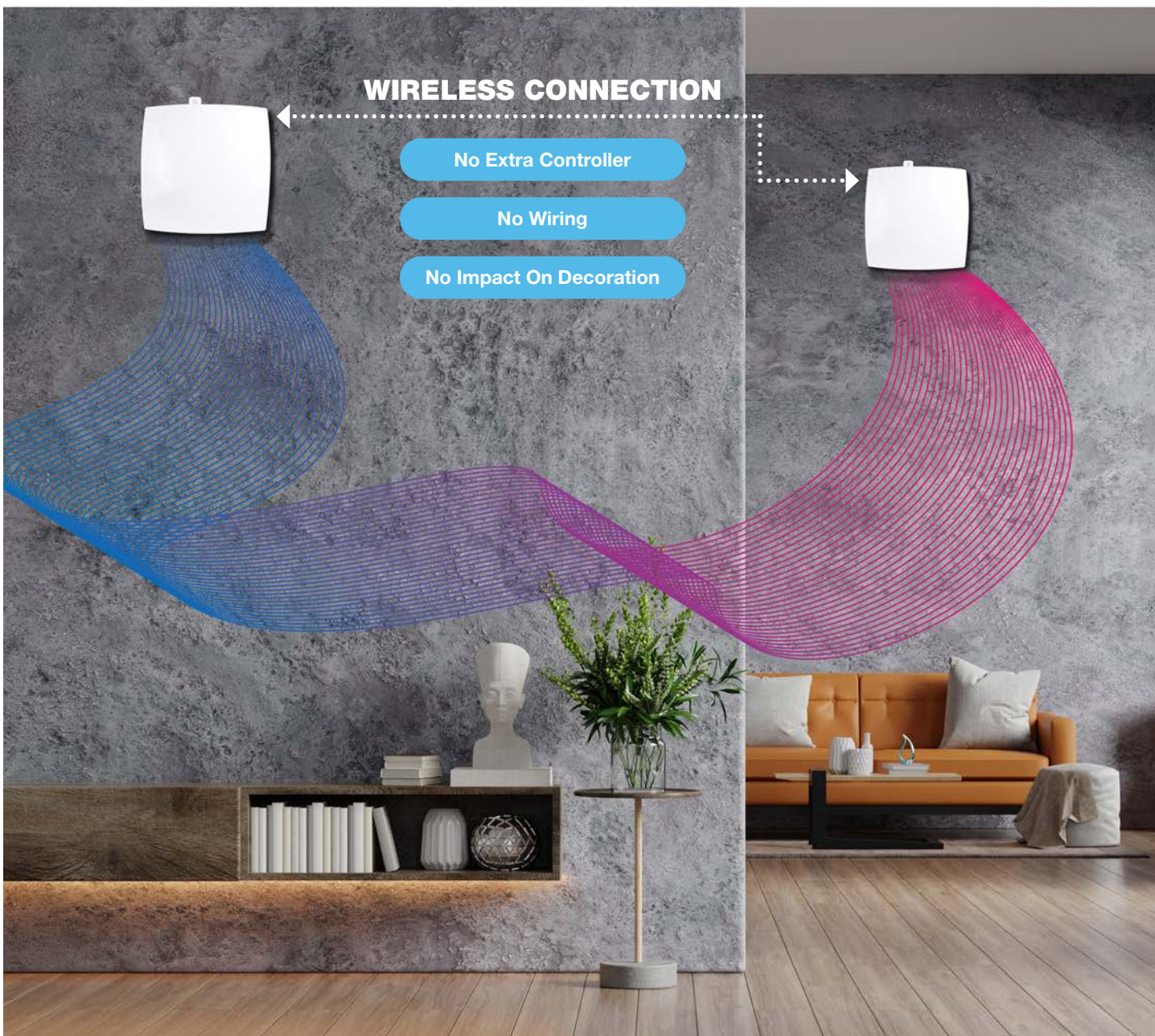

# ENERGY SAVING

The ventilator operates in the heat recovery mode with two cycles can save energy by over 30% compared with the normal exhaust fan. The heat recovery efficiency is up to 97% when the air first entering the heat regenerator. It can recover the energy in the room and reduce the load on the heating system in winter.



# ENERGY RECOVERY

The ventilator operates in the heat recovery mode with two cycles. Two units intake/exhaust air alternately at the same time to achieve balance ventilation. It will increase the indoor comfort and make ventilation more effective. The heat and humidity in the room can be recovered during ventilating and the load on cooling system can be reduced in summer.

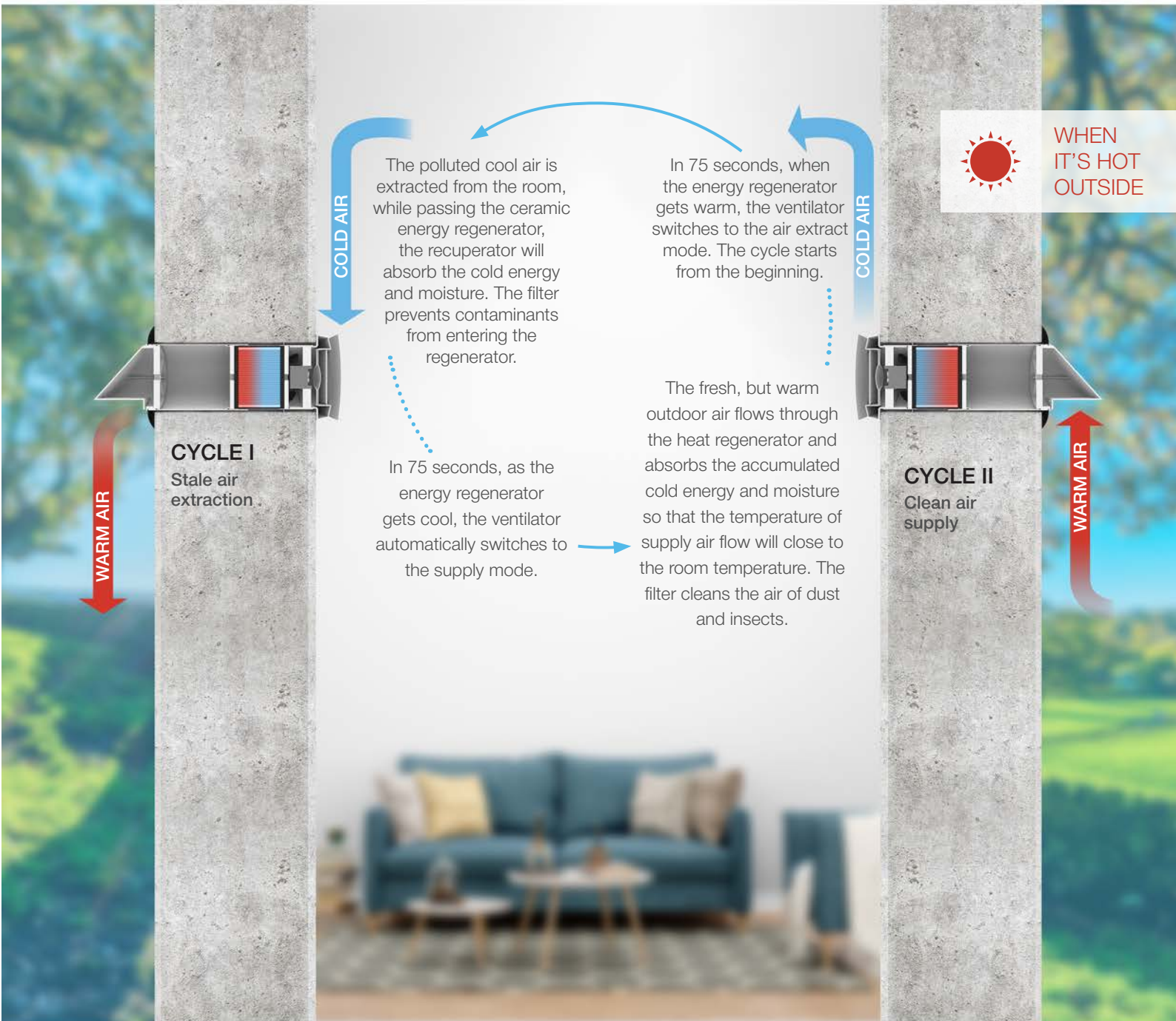

# PRODUCT STRUCTURE

## ● Reversible EC-Fan

The reversible axial fan with a EC motor. Due to the applied EC technology the fan is featured with low power consumption and silent operation. The fan motor has integrated thermal overheating protection and ball bearings for long service life.

## ● Air Filters

The two integrated air filters with total filtration rate G3 provide supply and extract air filtration. The filters prevent ingress of dust and insects into the supply air and contamination of the ventilator parts. The filters also have antibacterial treatment.

The filter cleaning is done with a vacuum cleaner or water flushing. The antibacterial solution is not removed. F7 filter is available as a specially ordered accessory, but when installed, it reduces the air flow down to 40 m<sup>3</sup>/h.

## ● Ceramic Energy Regenerator

The high-tech ceramic energy accumulator with regeneration efficiency up to 97% ensures extract air heat recovery for warming of supply air flow. Due to the cellular structure the unique regenerator has a large air contact surface and high heat-conducting and heat-accumulating properties.

The ceramic regenerator is treated with an antibacterial composition which prevents bacteria growth inside of the energy regenerator.

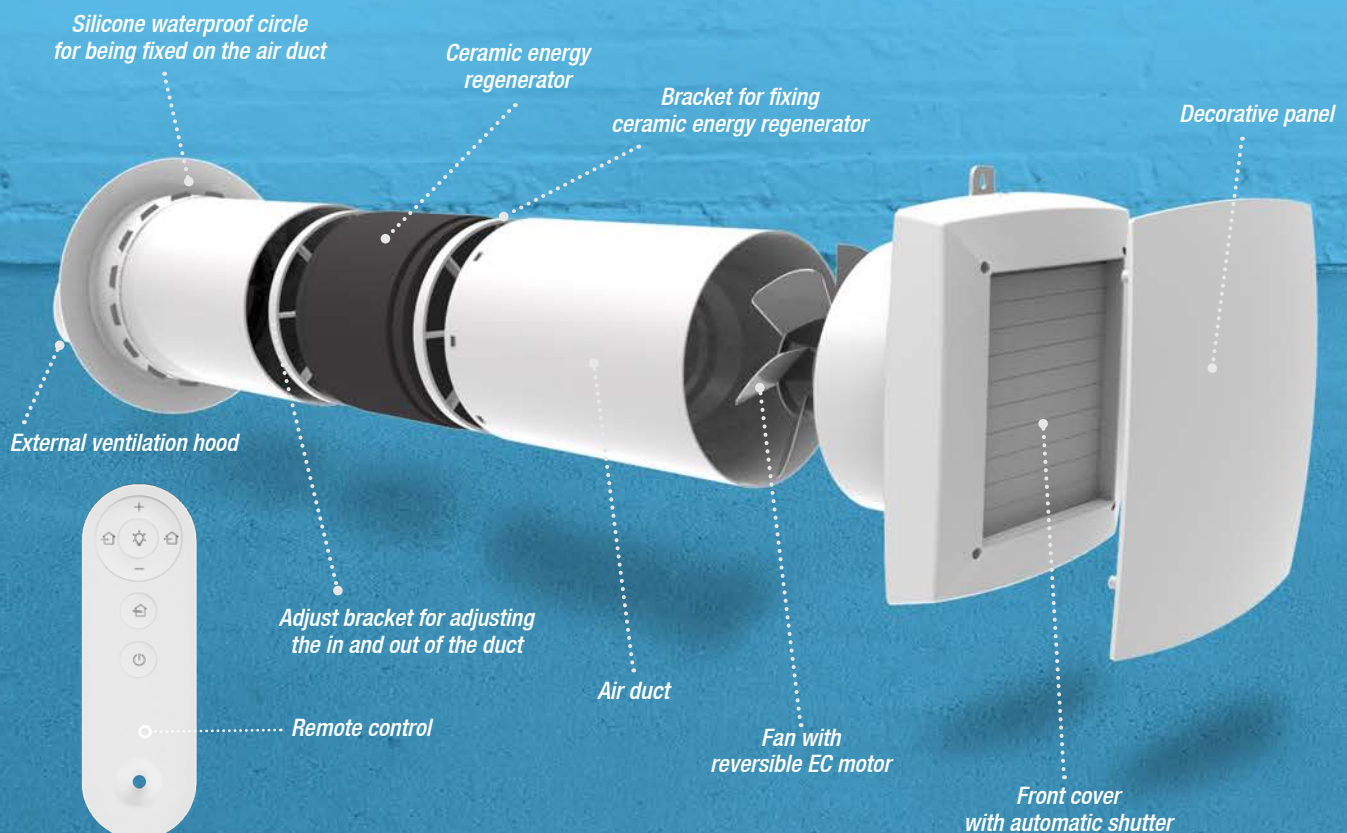

# LED DISPLAY



## LED Indicator

- The three leds only show the running status, you can turn off the led by the remote controller.
- The green shows as air supply.
- The red shows as air exhaust .
- The yellow shows as regeneration mode which is changed in 75s between the air supply and the air exhsust.
- 3 speed fan control for lighting the number of the led.
- The LED light is switchable.

# HOW TO WORK IN PAIRS

## Step 1 Master Ventilator Setting

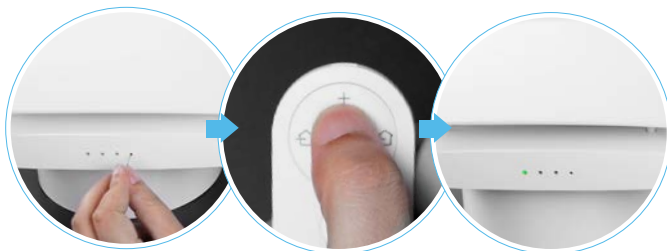

When the ventilator is powered on and switched off, use the needle to poke the reset button and press it twice quickly. The green LED will flash slowly, the unit enters the matching mode.

Then direct the remote to the unit with flashing light and press the button “+” on the remote to set the master unit. After the green LED flashes five times, the setting is done. (Note: One remote can only set one master unit.)

## Step 2 Slave Ventilator Setting

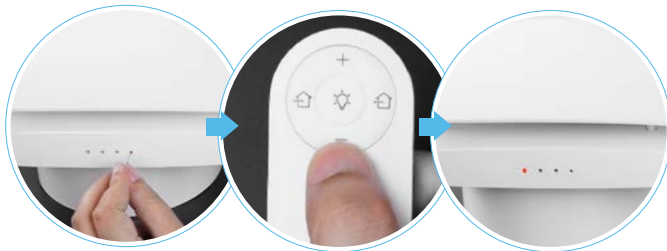

When the other ventilator is powered on and switched off, use the needle to poke the reset button and press it twice quickly. The green LED will flash slowly, the unit enters the matching mode.

Then use the same remote and direct it to the unit with flashing light and press the button “-” on the remote to set the slave unit. After the red LED flashes five times, the setting is done. (Note: Multiple units can be set as slave.)

## How To Delete The Setting

When the ventilator is powered on and switched off, use the needle to poke the reset button and long press it for 10s, the yellow LED light will flash three times, then the unit will return to factory state.

## Operation In Different Mode

The ON/OFF, LED light switch, and the increase and decrease of fan speed of the two ventilators are synchronized.



Regeneration Mode

Under regeneration model, the ventilators work in pair, one will extract air and the other will supply air. The fans rotate in different direction.



Supply Mode

Under supply mode, two ventilators will run simultaneously to supply air to the room.



Exhaust Mode

Under exhaust mode, two ventilators will exhaust air simultaneously.

# TECHNICAL DATA



Model No.	AV-TTW6-W		
Voltage	100V~240V AC /50-60Hz		
Power [W]	5.9	8.8	11.3
Current [A]	0.03	0.05	0.06
Air flow in regeneration mode [m <sup>3</sup> /h]	26	55	64
Air flow in energy recovery mode [m <sup>3</sup> /h]	14	27	32
SFP [W/m <sup>3</sup> /h]	0.43	0.31	0.35
Sound pressure level at 1 m distance [dBA]	28	32.9	36.7
Sound pressure level at 3 m distance [dBA]	12	27.5	31.9
Regeneration Efficiency	Up to 97%		
SEC	Class A		
Transported air temperature [°C]	-20~50		
Ingress Protection Rating	IP22		
RPM	2000 (max)		
Diameter of duct [mm]	159mm		
Type of installation	Wall mounting		
Net Weight	3.4kg		

# DIMENSIONS

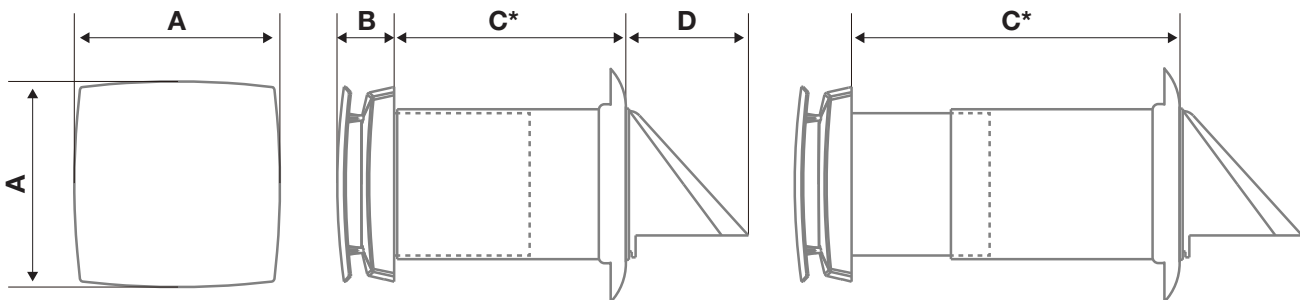



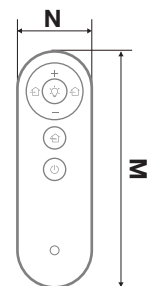







A	B	C*	D	M	N	Unit
205	60	230~420	129	128	38.5	mm



C\*: Size is customized, the length of 600 mm is optional.





# OTHER FANS AND ACCESSORIES

Product Name	Model	Airflow (m <sup>3</sup> /h)	Power (W)	Static Pressure (Pa)	Noise dB(A)	Pipe Diameter (mm)
 90° Supply fan	AV-C145-DA	145	11.2	61	30	100
 Exhaust fan	AV-C138-DB	138	3.8	42	37	150
	AV-C246-DB	246	4.5	20	36	190
 Ducted exhaust fan (Platic type)	AV-C182-DD-P	182	8.4	82.7	32.8	100
 Ducted exhaust fan (Metal type)	AV-C156-DD-M	156	12.5	155	41	100
	AV-C366-DD-M	366	27.3	242	45	150
 WIFI touch screen panel	ZSTY-SM-11W-EU	 Remote Control  Speech control	 Running Status Display  Linkage control	 Weekly timer  Scene control	Support TUYA APP, Able to connect to Alexa and Google Home devices in the home Wi-Fi network for speech control.	

## PROVIDES COMFORTABLE BREATHING ENVIRONMENT IN VARIOUS PREMISES

The room area for the ventilators in pairs is up to 50m<sup>2</sup>.

For example, if the room size is 100m<sup>2</sup>, it's suitable to use two pairs of AV-TTW6-W.

No.	Picture	Model	Number
1		AV-TTW6-W	2pcs
2		AV-TTW6-W	2pcs
3		AV-C145-DA, ZSTY-SM-11W-EU	1set
4		AV-C138-DB, ZSTY-SM-11W-EU	1set
5		AV-C138-DB, ZSTY-SM-11W-EU	1set

\*The area is approximate and depends on the ventilation standards in the user's country.



# GROUP CONTROL

The ventilator can create group control at the APP, the quantity is not limited. User can control all the ventilators in the group easily.

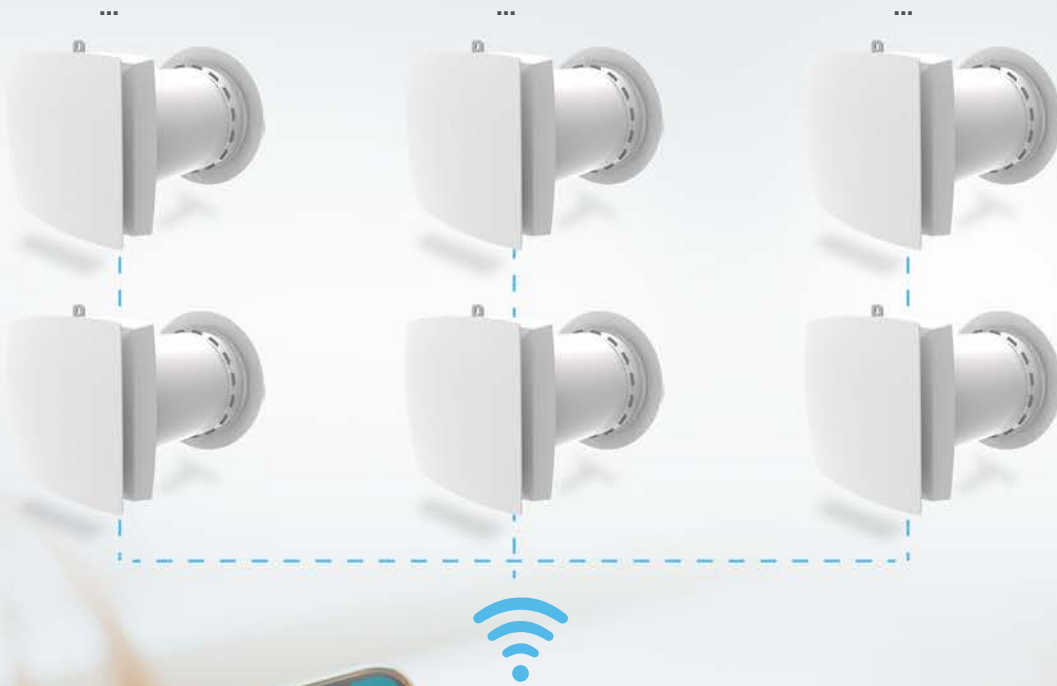
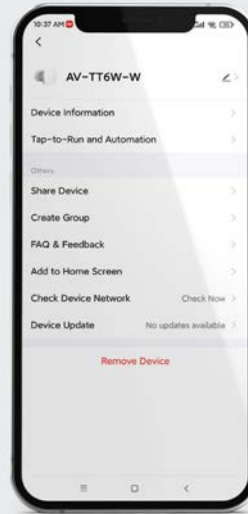

# SCENE CONTROL

User can create the scene according to the weather changes, schedule or the device status changes.

For example, when the weather shows the outdoor relative humidity is higher than 85%, user can set the ventilator to stop or run at exhaust mode, to prevent the outdoor humidity coming inside. The unit will run according to the setting automatically.

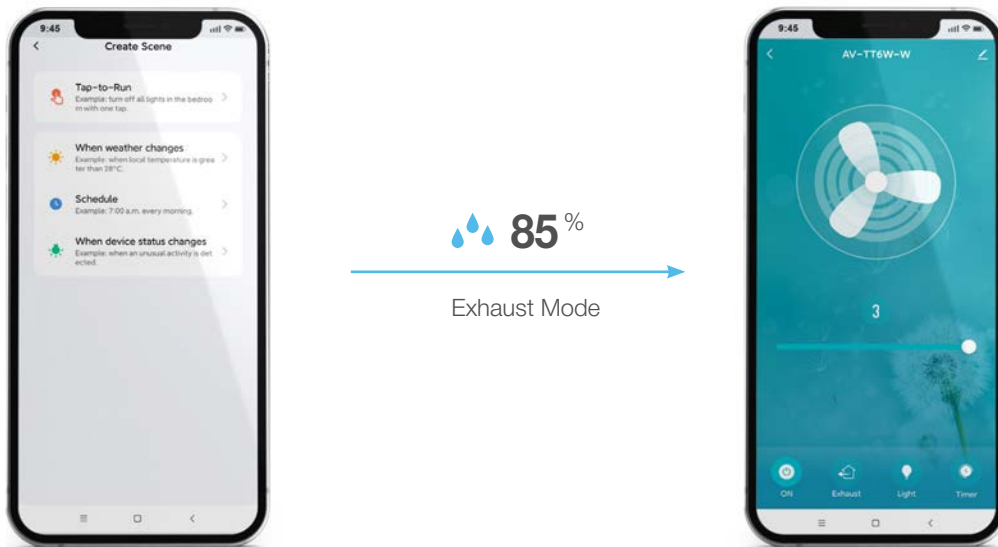

# LINKAGE CONTROL

Users can add the devices with Tuya APP to their home screen. For example, they can add all the single room ventilators, exhaust fans or light switches in the APP and control them at their will.

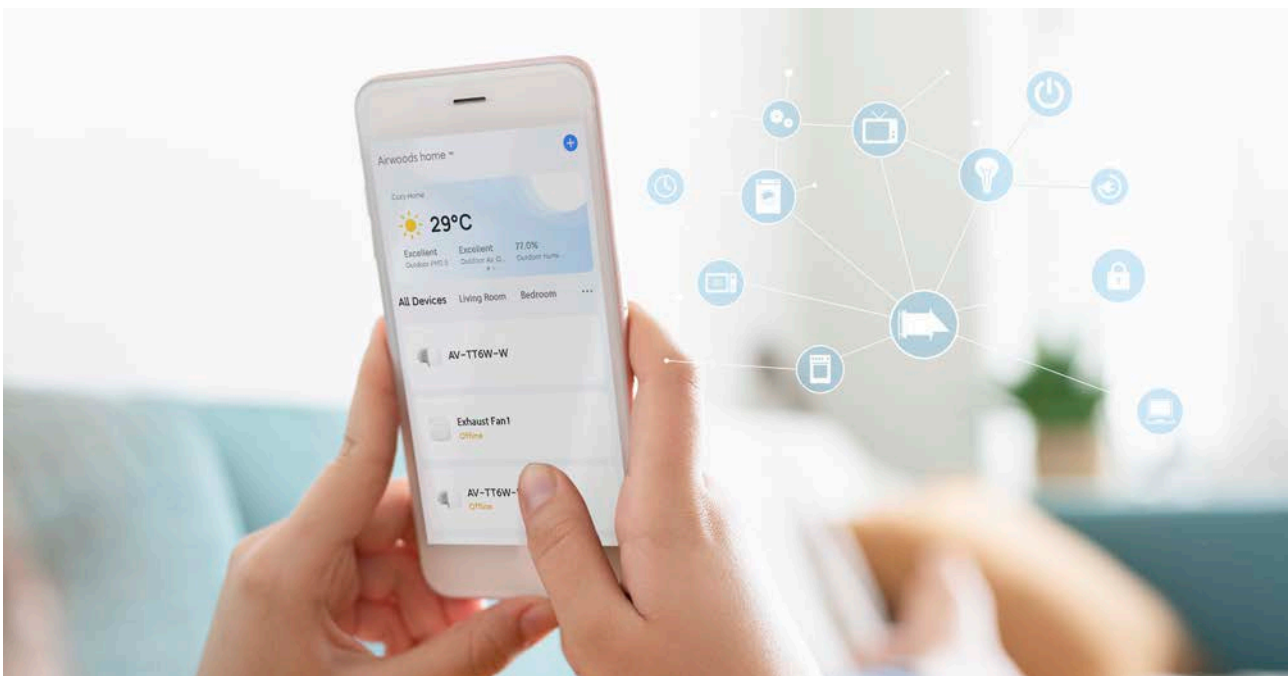

# **ECO PAIR ERV, EASIER ACCESS TO HEALTHY BREATH**

**Guangzhou Airwoods Environment Technology Co., Ltd.**

[www.airwoods.com](http://www.airwoods.com)

[info@airwoods.com](mailto:info@airwoods.com)